

FRONT VIEW

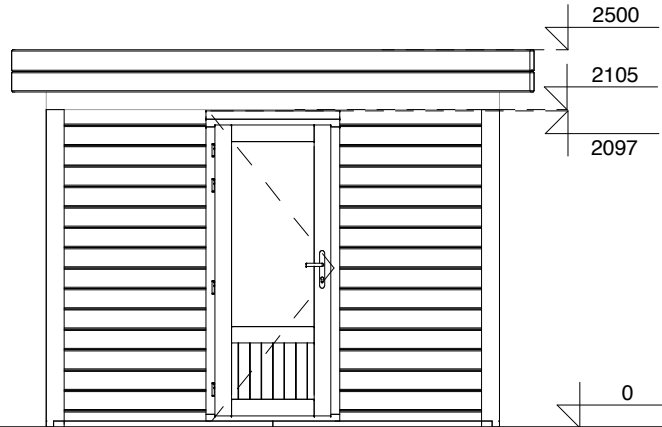

RIGHT SIDE VIEW

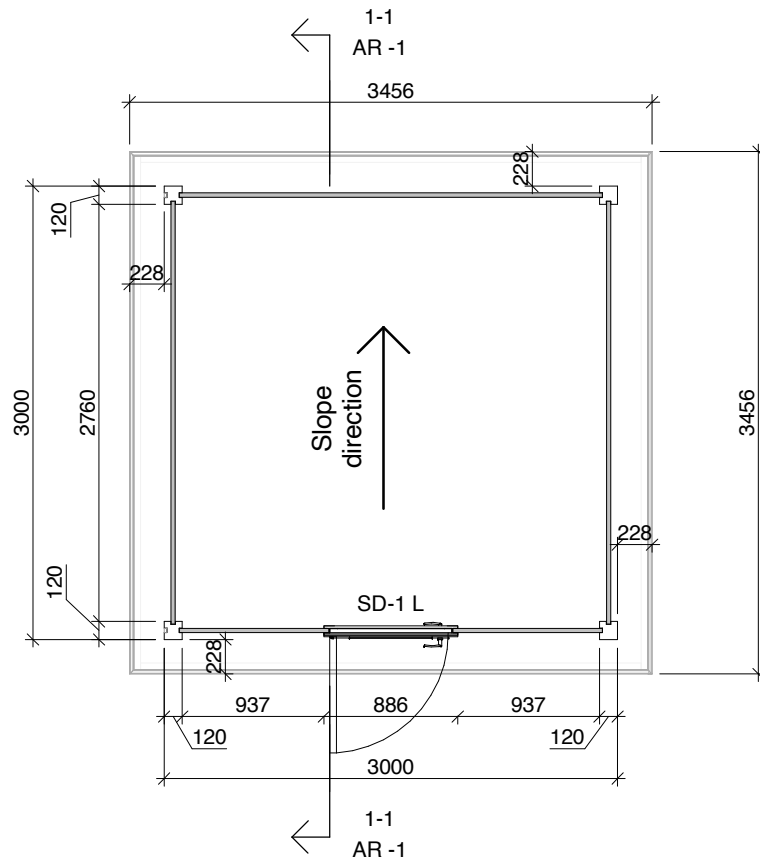
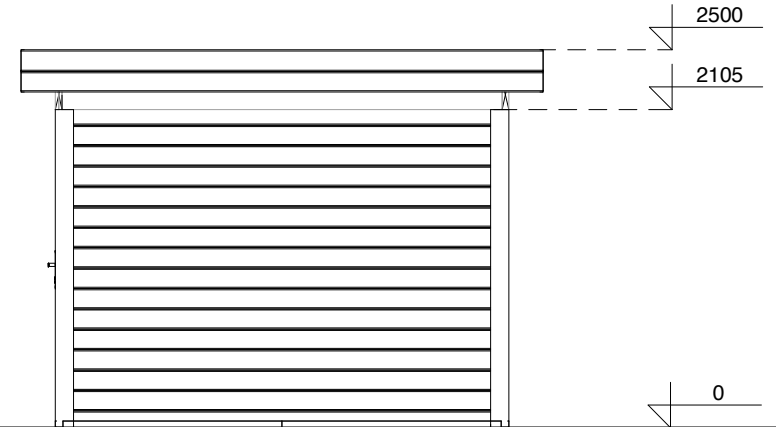

FLOOR PLAN

SECTION 1-1

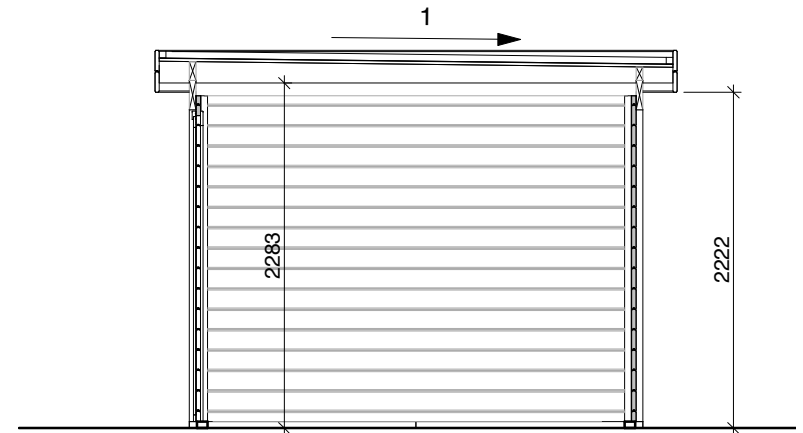

Project Nr.

PL 02-21 DS HOUSE PREMIUM LINE CABIN 3x3m

ARCHITECTURE DRAWINGS	Scale	Drawer	Sheet Nr.	Date
	1 : 50	RB	AR -1	23.11.2021 08:25:28

REAR VIEW

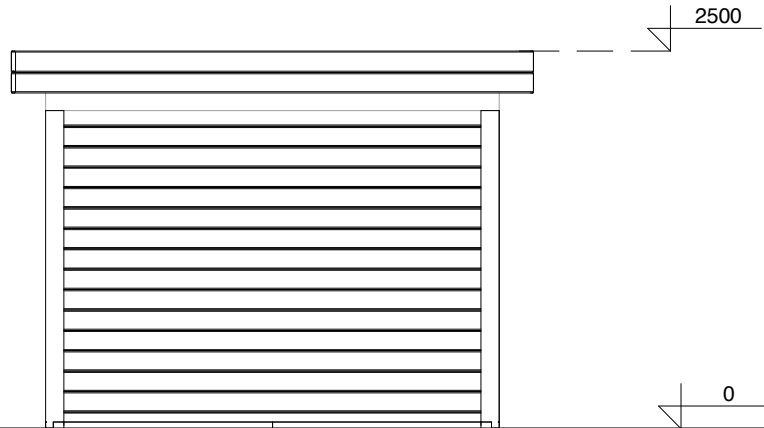

LEFT SIDE VIEW

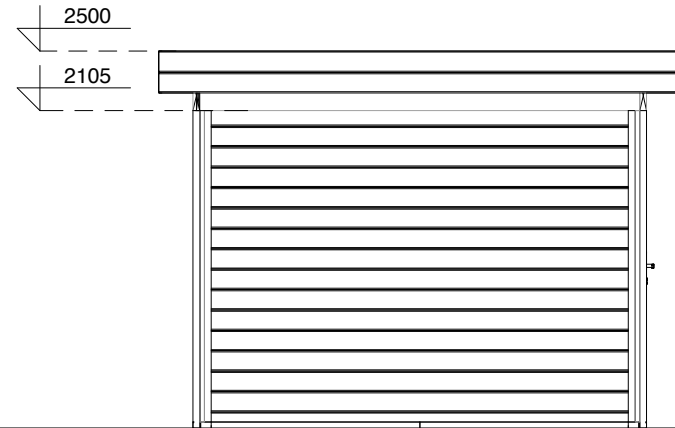

3D VIEW

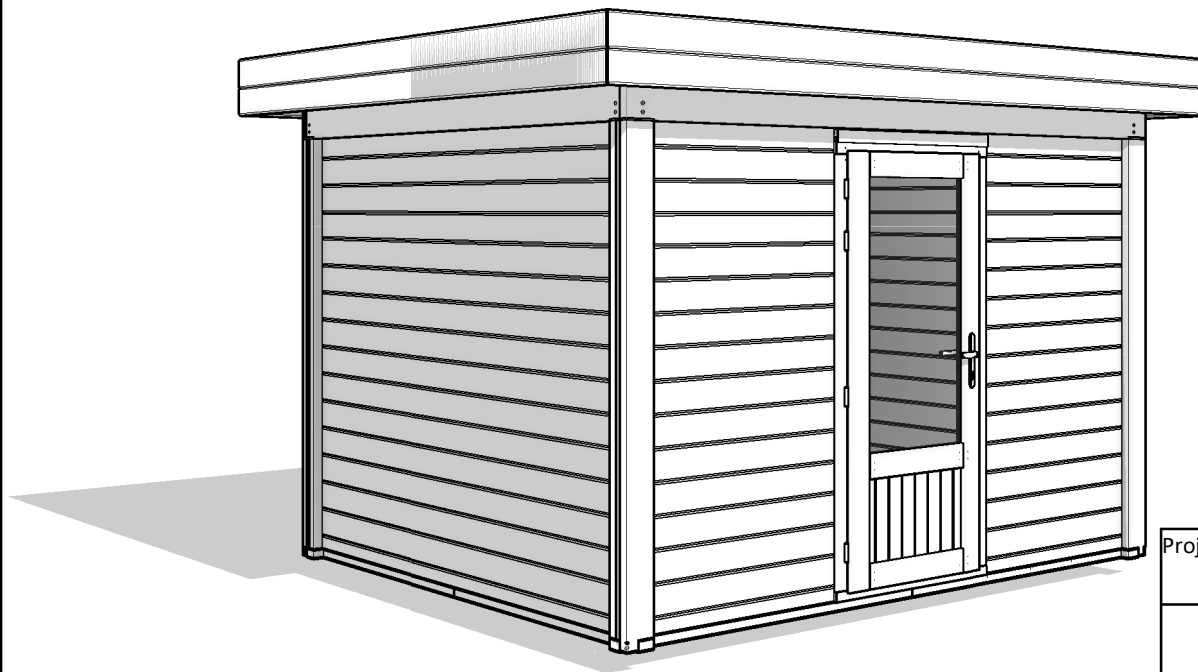

Project Nr.

PL 02-21 DS HOUSE PREMIUM LINE CABIN 3x3m

ARCHITECTURE
DRAWINGS

Scale

1 : 50

Drawer

RB



Sheet Nr.

AR -2

Date

23.11.2021
08:24:45

ROOF PART SPECIFICATION

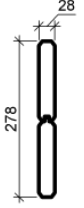
Type Image	Keynote	Description
	PFB	PFB 19x29
	RB	Roof board 18mm
	RS 44x44	Roof side board 44x44
	WB 28	Wind board 28mm

FLOOR PART SPECIFICATION

Type Image	Keynote	Description
	BB 44x70	Base beam 44x70

DOOR SCHEDULE

Keynote	Count
SD-1 L	1

WINDOW SCHEDULE

Keynote	Count
---------	-------

ROOF SCHEDULE

Roof cover	Area
EPDM	12 m ²

FLOOR SCHEDULE

Description	Area
-------------	------

Project Nr.

PL 02-21 DS HOUSE PREMIUM LINE CABIN 3x3m

ARCHITECTURE
DRAWINGS

Scale

Drawer

Sheet Nr.

Date

RB

AR - 3

23.11.2021
08:24:55

FRONT VIEW

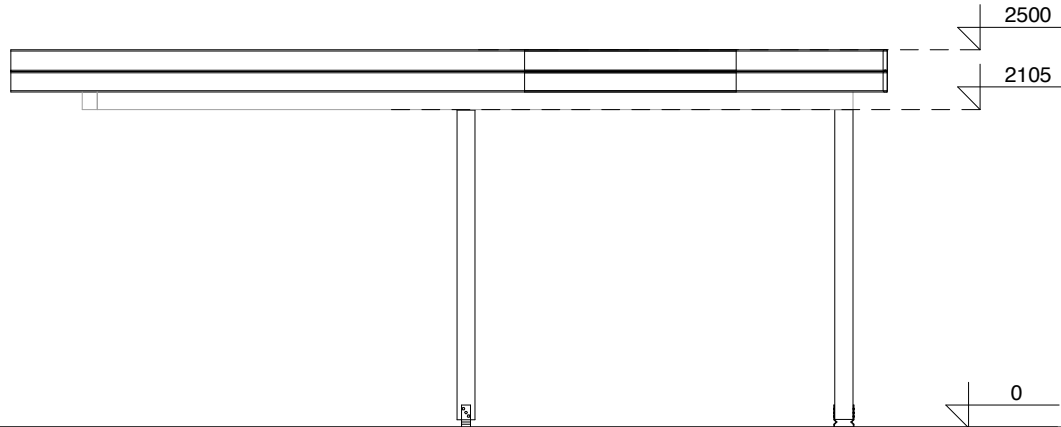

RIGHT SIDE VIEW

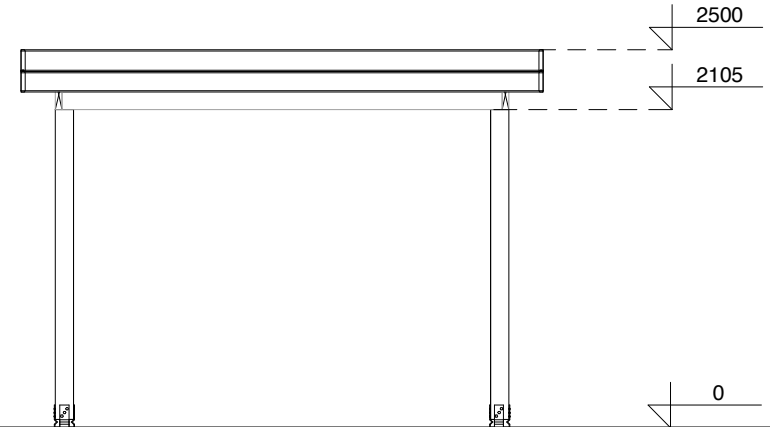

SECTION 1-1

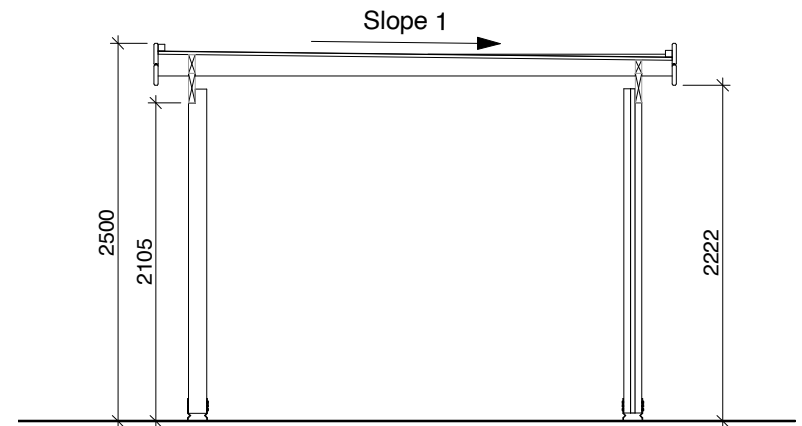

1-1
AR -1

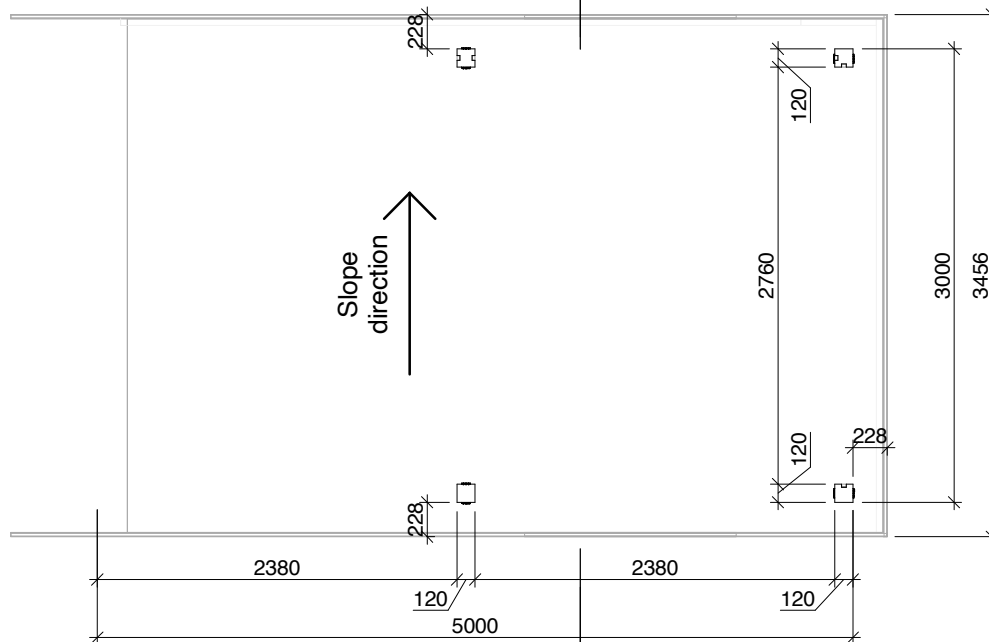

FLOOR PLAN

1-1
AR -1

Project Nr.

PL 08-21 DS HOUSE PREMIUM LINE CANOPY 5x3m

ARCHITECTURE
DRAWINGS

Scale

1 : 50

Drawer

RB

Sheet Nr.

AR -1

Date

24.11.2021
08:10:19

REAR VIEW

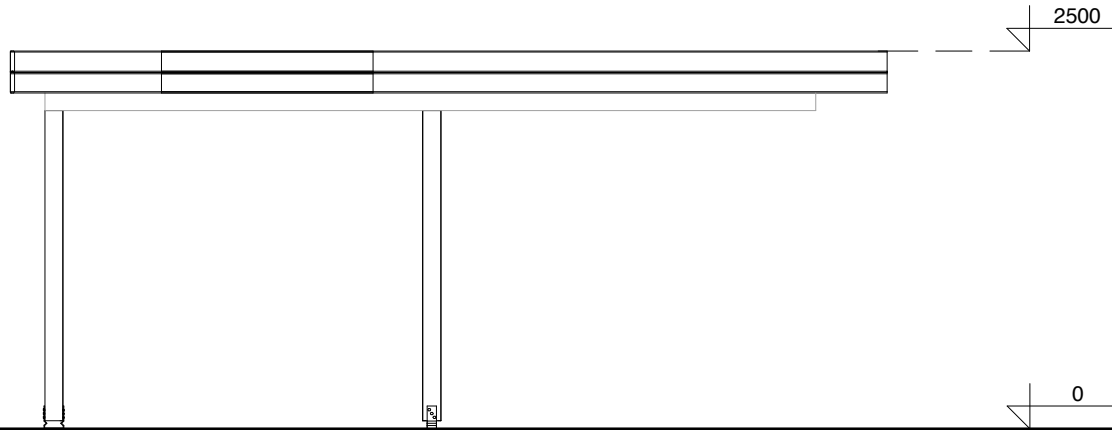

LEFT SIDE VIEW

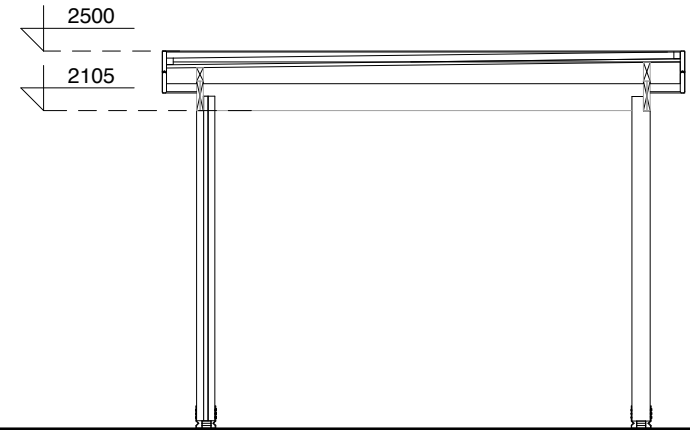

3D VIEW

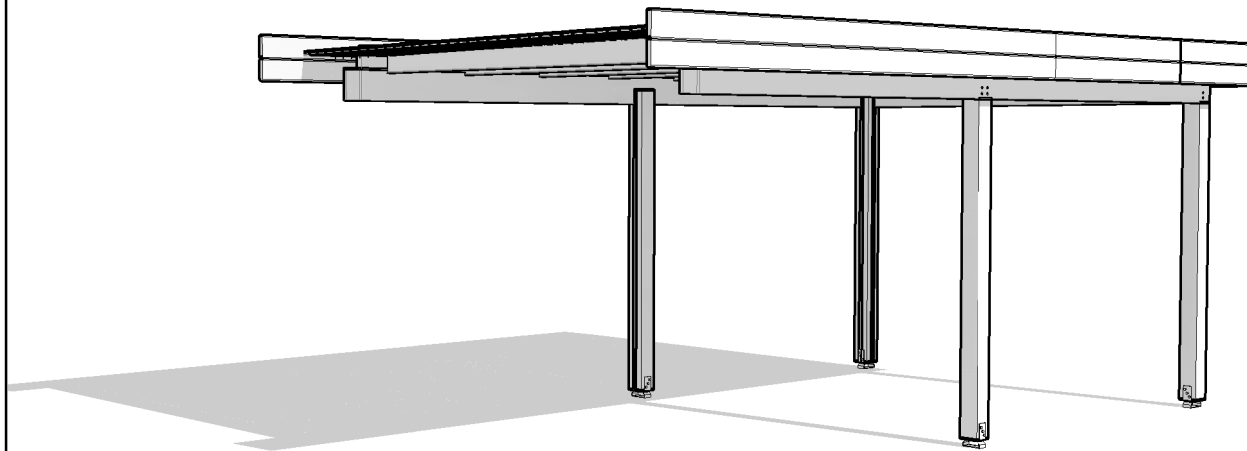

Project Nr. **PL 08-21 DS HOUSE PREMIUM LINE CANOPY 5x3m**

ARCHITECTURE
DRAWINGS



Scale
1 : 50

Drawer
RB

Sheet Nr.
AR -2

Date
24.11.2021
08:10:20

ROOF PART SPECIFICATION

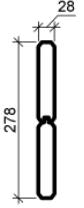
Type Image	Keynote	Description
	PFB	PFB 19x29
	RB	Roof board 18mm
	RS 44x44	Roof side board 44x44
	WB 28	Wind board 28mm

FLOOR PART SPECIFICATION

Type Image	Keynote	Description
------------	---------	-------------

DOOR SCHEDULE

Keynote	Count
---------	-------

WINDOW SCHEDULE

Keynote	Count
---------	-------

ROOF SCHEDULE

Roof cover	Area
EPDM	17 m ²

FLOOR SCHEDULE

Description	Area
-------------	------

Project Nr.

PL 08-21 DS HOUSE PREMIUM LINE CANOPY 5x3m

ARCHITECTURE
DRAWINGS

Scale

Drawer

Sheet Nr.

Date

RB

AR - 3

24.11.2021
08:10:20